

MP-Series Low-inertia Servo Motor with 100 mm to 165 mm Frame Size

Catalog Numbers MPL-A310, MPL-A320, MPL-A330, MPL-A420, MPL-A430, MPL-A4530, MPL-A4540, MPL-A4560, MPL-A520, MPL-A540, MPL-A560, MPL-B310, MPL-B320, MPL-B330, MPL-B420, MPL-B430, MPL-B4530, MPL-B4540, MPL-B4560, MPL-B520, MPL-B540, MPL-B560, MPL-B580

Topic	Page
Important User Information	2
Catalog Number Explanation	3
About the MP-Series Low-inertia Motors	4
Before You Begin	4
Install the Motor	9
Motor with ATEX Rating Installations	13
Product Dimensions	14
Motor Load Force Ratings	18
Connector Data	20
Remove and Install a Shaft Key	22
Motor Cables and Accessory Kits	23
Specifications	24
Additional Resources	25

Important User Information

Read this document and the documents listed in the additional resources section about installation, configuration, and operation of this equipment before you install, configure, operate, or maintain this product. Users are required to familiarize themselves with installation and wiring instructions in addition to requirements of all applicable codes, laws, and standards.

Activities including installation, adjustments, putting into service, use, assembly, disassembly, and maintenance are required to be carried out by suitably trained personnel in accordance with applicable code of practice.

If this equipment is used in a manner not specified by the manufacturer, the protection provided by the equipment may be impaired.

In no event will Rockwell Automation, Inc. be responsible or liable for indirect or consequential damages resulting from the use or application of this equipment.

The examples and diagrams in this manual are included solely for illustrative purposes. Because of the many variables and requirements associated with any particular installation, Rockwell Automation, Inc. cannot assume responsibility or liability for actual use based on the examples and diagrams.

No patent liability is assumed by Rockwell Automation, Inc. with respect to use of information, circuits, equipment, or software described in this manual.

Reproduction of the contents of this manual, in whole or in part, without written permission of Rockwell Automation, Inc., is prohibited.

Throughout this manual, when necessary, we use notes to make you aware of safety considerations.



WARNING: Identifies information about practices or circumstances that can cause an explosion in a hazardous environment, which may lead to personal injury or death, property damage, or economic loss.



ATTENTION: Identifies information about practices or circumstances that can lead to personal injury or death, property damage, or economic loss. Attentions help you identify a hazard, avoid a hazard, and recognize the consequence.

IMPORTANT

Identifies information that is critical for successful application and understanding of the product.

Labels may also be on or inside the equipment to provide specific precautions.



SHOCK HAZARD: Labels may be on or inside the equipment, for example, a drive or motor, to alert people that dangerous voltage may be present.



BURN HAZARD: Labels may be on or inside the equipment, for example, a drive or motor, to alert people that surfaces may reach dangerous temperatures.



ARC FLASH HAZARD: Labels may be on or inside the equipment, for example, a motor control center, to alert people to potential Arc Flash. Arc Flash will cause severe injury or death. Wear proper Personal Protective Equipment (PPE). Follow ALL Regulatory requirements for safe work practices and for Personal Protective Equipment (PPE).

Catalog Number Explanation

MP L - x x 10 x - x x x x A x

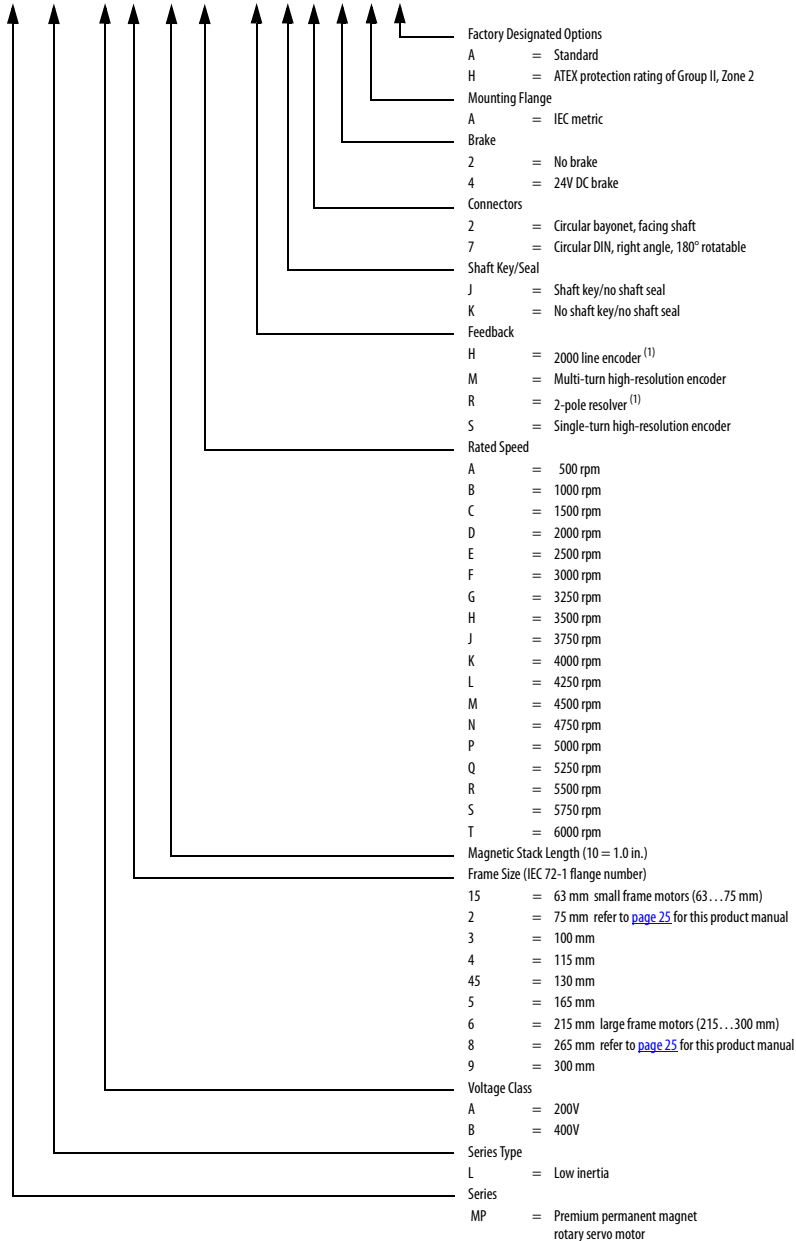

(1) Not available on catalog number MPL-x5xxx or larger (>165 mm frame sizes).

About the MP-Series Low-inertia Motors

MP-Series™ low-inertia (Bulletin MPL) motors feature single-turn or multi-turn high resolution encoders, and are available with 24V DC brakes. These compact brushless servo motors meet the demanding requirements of high-performance motion systems.

Before You Begin

Remove all packing material from within and around the item. After unpacking, verify the nameplate catalog number against the purchase order.



ATTENTION: To avoid personal injury and damage to the motor, do not lift or handle the motor by the motor shaft. The cap on the shaft can come loose and cause you to drop the motor.

1. Remove the motor carefully from its shipping container.
2. Visually inspect the motor for any damage.
3. Examine the motor frame, front output shaft, and mounting pilot for any defects.
4. Notify the carrier of any shipping damage immediately.

Keep the original packing material in case you need to return the product for repair or transport it to another location. Use both the inner and outer packing cartons to provide adequate protection for a unit returned for service.



ATTENTION: Do not attempt to open and modify the motor beyond changing the connector orientation as described in [Change the Orientation of the Connectors on page 9](#).

Only an authorized Allen-Bradley repair center can service this item. Refer to Rockwell Automation Support for assistance to locate the nearest repair center.

Store or operate your motor in a clean and dry location within the environmental conditions listed in [Specifications on page 24](#).

Removing the Shaft Cap

Use your hand to remove the protective cap that is installed on the motor shaft or pry off the cap with a screwdriver. Do not use a hammer or other tools as they can damage the motor shaft.

Prolonging Motor Life

Proper design and maintenance can increase the life of a servo motor. Follow these guidelines to maximize the life of a servo motor within your environment:

- Always provide a drip loop in each cable to carry liquids away from the connection to the motor.

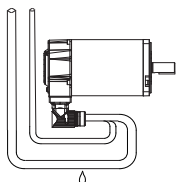

The cable enters beneath the motor and forms a drip loop.

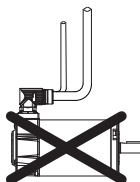

The cable enters above the motor and does not form a drip loop.

- If possible, provide shields that protect the motor housing, shaft seals, and their junctions from contamination by foreign matter or fluids.
- Shaft seals are subject to wear and require periodic inspection and replacement. Replacement is recommended every 3 months, not to exceed 12 months, depending on use. Refer to [Shaft Seal Kits on page 23](#) for more information on shaft seals.
- Inspect the motor and seals for damage or wear on a regular basis. If damage or excessive wear is observed, replace the item.
- The brake option on this servo motor is a spring-set holding brake that releases when voltage is applied to the brake coil. A separate power source is required to disengage the brake. This power source can be applied by a servo motor controller or manual operator control.

If system main power fails, holding brakes can withstand occasional use as stopping brakes. However, this creates rotational mechanical backlash that can cause damage to the system, increase brake wear, and reduce brake life.

IMPORTANT Holding brakes are not designed to stop rotation of the motor shaft, and they are not intended to be used as a safety device. They are designed to hold a motor shaft at 0 rpm for up to the rated brake holding torque.

Follow these steps to prevent motor shaft rotation.

1. Command the servo drive to 0 rpm.
2. Verify the motor is at 0 rpm.
3. Engage the brake.
4. Disable the drive.

Disabling the drive removes the potential for brake wear caused by a badly-tuned servo system oscillating the shaft.

Using Shaft Seals

An additional seal is required on the motor shaft near the motor front bearing if the shaft is exposed to fluids or significant amounts of fine dust. This includes lubricating oil from a gearbox. An IP66 rating for the motor requires the use of a shaft seal and environmentally sealed connectors/cables. The additional seal is not recommended in applications where the motor shaft area is free of liquids or fine dust, and a lower rating is sufficient:

- Refer to [Specifications on page 24](#) for a brief description of the IP rating for these MP-Series motors.
- Refer to [Shaft Seal Kits on page 23](#) to find the catalog numbers of seal kits available for your motor.
- Refer to Kinetix® Motion Accessories Specifications, publication [GMC-TD004](#), to find environmentally sealed connectors and cables compatible with the MP-Series motors.

Using Couplings and Pulleys

Mechanical connections to the motor shaft, such as couplings and pulleys, require a torsionally rigid coupling or a reinforced timing belt. The high dynamic performance of servo motors can cause couplings, pulleys, or belts to loosen or slip over time. A loose or slipping connection can cause system instability and damage the motor shaft. All connections between the system and the servo motor shaft must be rigid to achieve acceptable response from the system. Periodically inspect connections to verify their rigidity.

When mounting couplings or pulleys to the motor shaft, be sure that the connections are properly aligned and that axial and radial loads are within the specifications of the motor. Refer to [Motor Load Force Ratings on page 18](#) for guidelines to achieve 20,000 hours of motor bearing life.



ATTENTION: Damage can occur to the motor bearings and the feedback device if sharp impact to the shaft is applied during installation of couplings and pulleys. Damage to the feedback device can result by applying leverage from the motor mounting face to remove devices mounted on the motor shaft.

Do not strike the shaft, couplings, or pulleys with tools during installation or removal. Use a wheel puller applying pressure from the user end of the shaft to remove any friction-fit or stuck device from the motor shaft.

Preventing Electrical Noise

Electromagnetic interference (EMI), commonly called noise, can cause poor motor performance by inducing stray signals.

Follow these guidelines to prevent the effects of EMI:

- Isolate the power transformers, or install line filters on all AC input power lines.
- Separate signal cables from motor cabling and power wiring. Do not route signal cables with motor and power wires, or over the vent openings of servo drives.
- Ground all equipment by using a single-point parallel ground system that employs ground bus bars or large straps. If necessary, use additional electrical noise reduction techniques to reduce EMI in noisy environments.

Refer to System Design for Control of Electrical Noise Reference Manual, publication [GMC-RM001](#), for additional information on reducing the effects of EMI by improving the system level electromagnetic compatibility (EMC).

Build and Install the Cables

Correct cable routing and careful cable construction improves system electromagnetic compatibility (EMC).

Follow these guidelines to build and install the cables:

- Keep the wire lengths as short as possible.
- Route noise sensitive wiring (encoder, serial, and I/O) away from input power and motor power wiring.
- Separate cables by 0.3 m (1 ft) minimum for every 9 m (30 ft) of parallel run.
- Ground both ends of the encoder cable shield and twist the signal wire pairs to prevent EMI from other equipment.



ATTENTION: High voltage can be present on the shield of a power cable, if the shield is not grounded.

Verify that there is a connection to ground for any power cable shield.



ATTENTION: MP-Series motors produce leakage current in the protective earthing conductor that exceeds 3.5 mA AC and/or 10 mA DC.

Be sure to properly ground the motor cables per the drive installation instructions.

Ground Shielded Signal Wires within a Power Cable

Always connect the shield on any signal wire pair routed inside a power cable to the overall machine ground.

If you are installing a 2090-XXNPMF-xxSxx or 2090-CPBM4DF-xxAFxx power with brake cable, loop the signal wire pairs to the overall cable shield as shown in [Grounding of Signal Wire Shields in a Power Cable on page 8](#). Then clamp all of the shields together in the power cable (chassis) ground connection on the drive.

Grounding of Signal Wire Shields in a Power Cable

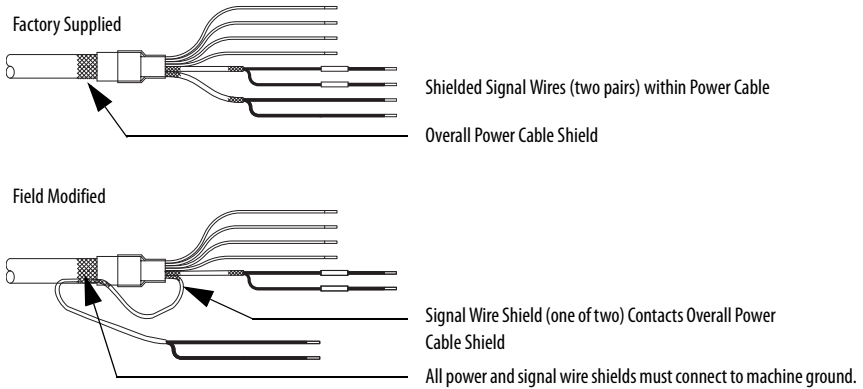

2090-XXNPMF-xxSxx (shown) contains two signal wire pairs.
2090-CPBM4DF-xxAFxx contains one signal wire pair.

The diagram shows one of the two signal wires in the correct position. Connect both signal wire shields and the overall power cable shield to machine ground.

The signal wire pairs within a power cable often carry a 24V DC brake signal, but can also carry logic signals. Grounding the shield that surrounds the signal wires dissipates an induced voltage and reduces the effects of EMI.

Install the Motor

MP-Series motors include a mounting pilot for aligning the motor on the machine. Preferred fasteners are stainless steel. The installation must comply with all local regulations and use equipment and installation practices that promote safety and electromagnetic compatibility.



ATTENTION: Unmounted motors, disconnected mechanical couplings, loose shaft keys, and disconnected cables are dangerous if power is applied.

Lock-out and tag-out disassembled equipment (restrict electrical power).

Before applying power to the motor, remove the shaft key and other mechanical couplings that can be thrown from the shaft.



ATTENTION: Make sure that cables are installed and restrained to prevent uneven tension or flexing at the cable connections.

Excessive and uneven lateral force on the cable can inhibit environmental sealing as the cable flexes.

Change the Orientation of the Connectors

MP-Series motors use two styles of connectors. The connector style is identified by a 2 or a 7 as the connector variable in the motor catalog number. For example, MPx-xxxxx-xx2xxx or MPx-xxxxx-xx7xxx:

- A 2 indicates a circular bayonet connector, facing the shaft.
- A 7 indicates a circular DIN, right angle, rotatable connector.

Rotatable Circular DIN Connector (catalog number MPL-xxxxx-xx7xxx)

The circular DIN connector housing can be rotated up to 180° in either direction.



ATTENTION: Connectors are designed to be rotated into a fixed position during motor installation, and remain in that position without further adjustment. Do not rotate the connector multiple times, and do not use tools or excessive force to rotate the connector. Excessive rotation or force can damage the connector seal and reduce the international protection (IP) rating of the motor as outlined in [Specifications on page 24](#).

Follow these steps to turn the DIN connectors.

1. Mount and fully seat a mating cable on the connector.
2. Grasp both connectors by their housings and slowly rotate them to the outside of the motor.

If necessary, repeat this step for each connector (feedback or power/brake).

Apply force to only the connectors; do not apply force to the cable. Do not use tools (for example, pliers and vise-grips) to rotate the connector.

Mount the Motor

Follow these steps to mount the motor.



ATTENTION: Damage can occur to the motor bearings and the feedback device if sharp impact to the shaft is applied during installation of couplings and pulleys.

Do not strike the shaft, couplings, or pulleys with tools during installation or removal.

1. Provide sufficient clearance, heatsink mass, and airflow for the motor so it stays within the operating temperature range of 0...40 °C (32...104 °F).

Do not enclose the motor unless forced air is blown across the motor for cooling. Keep other heat producing devices away from the motor. Heatsink requirements are listed in a footnote to the [Specifications on page 24](#).



ATTENTION: Outer surfaces of the motor can reach high temperatures of 125 °C (257 °F) during operation.

Take precautions to prevent accidental contact with hot surfaces. Consider motor surface temperature when selecting motor mating connections and cables.

2. Verify the axial and radial shaft loads of your application do not exceed those listed in the [Motor Load Force Ratings on page 18](#).
3. Place the motor with the connector housing pointing downward.
4. Mount and align the motor.

Electronic zero (index pulse or Stegmann ABS = 0) occurs when the shaft key or dimple is aligned with the connectors.

Refer to [Mounting Dimensions](#) for a visual reference of this alignment.

Attach the Motor Cables

Follow these steps to attach the feedback and power/brake cables after the motor is mounted.



ATTENTION: Servo drive power must be turned off before connecting or disconnecting the cables to the motor, and if a cable is left disconnected at the motor end.

Arcing or unexpected motion can occur if the feedback, power, or brake cables are connected or disconnected while power is applied to the servo drive.



ATTENTION: Be sure that cables are installed and restrained to prevent uneven tension or flexing at the cable connectors. Provide support at 3 m (10 ft) intervals throughout the cable run.

Excessive and uneven lateral force at the cable connectors can result in the connector's environmental seal opening and closing as the cable flexes, or wires separating at the cable gland.

1. If you are using the **Threaded DIN (M4) Cable Plugs**, install the O-rings.

An O-ring on the connector is necessary to achieve the maximum environmental rating.

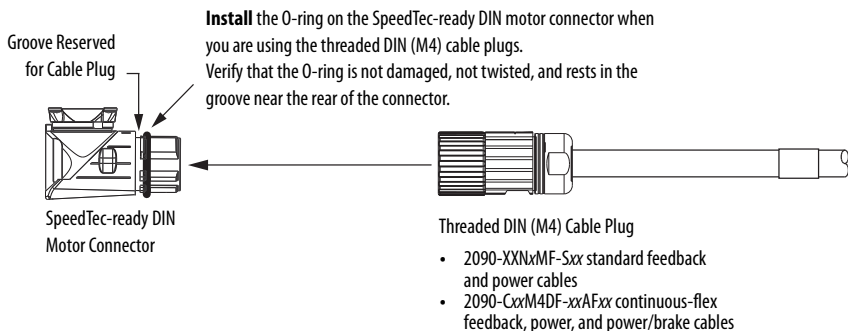

2. If you are using the **SpeedTec DIN (M7) Cable Plugs**, do not install the O-rings.

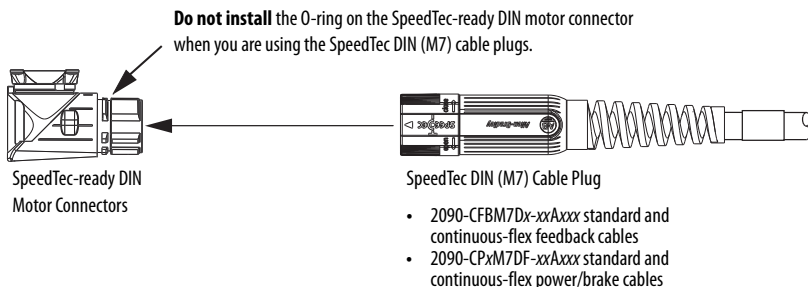

3. Form a drip loop in the cable (see [page 5](#)).

- Carefully align the flat surface on the feedback or the power/brake cable plug (shown in the diagram) with the flat surface on the motor connector.

IMPORTANT The motor orientation shown is used to clearly show the alignment marker on each cable socket.

The recommended motor orientation when installed positions the connectors at the bottom of the motor.

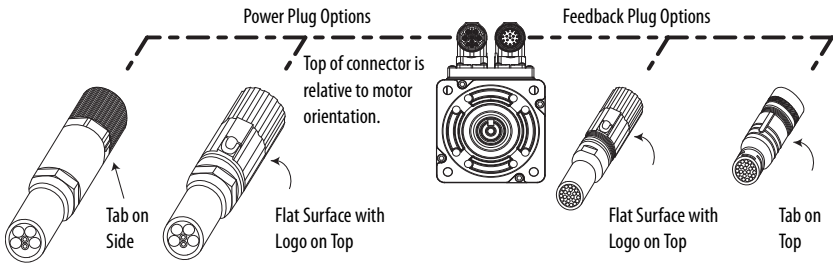

Connector plugs have either a tab or a flat surface with a logo to indicate the alignment point.

- Hand tighten the collar on the plug to fully seat it on the connector:
 - Threaded DIN (M4) cable plugs require five to six revolutions.
 - SpeedTec DIN (M7) cable plugs require approximately one-quarter of a revolution.

TIP A fully-seated threaded plug leaves a small opening, approximately 1...4 mm (0.04...0.16 in.), between the connector and the plug.

Do not apply excessive force when mating the cable plug with the motor connector. If the plug and connector do not go together with light hand force, realign the flat surfaces and try again.



ATTENTION: Align the keyed connectors and hand-tighten the recommended number of turns.

If you cannot tighten the connectors by hand, verify that the keyed connectors are properly aligned. Do not use tools (for example, pliers and vise-grips) to tighten the connectors.

Motor with ATEX Rating Installations

If your motor has an ATEX rating for hazardous environments, complete the following step. The catalog number on ATEX motor nameplates ends with H, for example MPL-xxxx-xxxxxH.

Verify the continuity and functionality of the thermal switch signals, TS+ and TS-, transmitted through the feedback cable that connects the motor to its controlling drive.



ATTENTION: It is mandatory that the motion system monitor the thermal switch signals from a motor requiring an ATEX rating.

The intrinsic safety protection concepts in the ATEX Directive 94/9/EC must be enabled by connecting the thermal switch signals from the motor to the motion control system.

Product Dimensions

This section provides dimensions for the motors.

Dimensions for Bayonet Connectors (catalog number MPL-xxxx-xx2xxx)

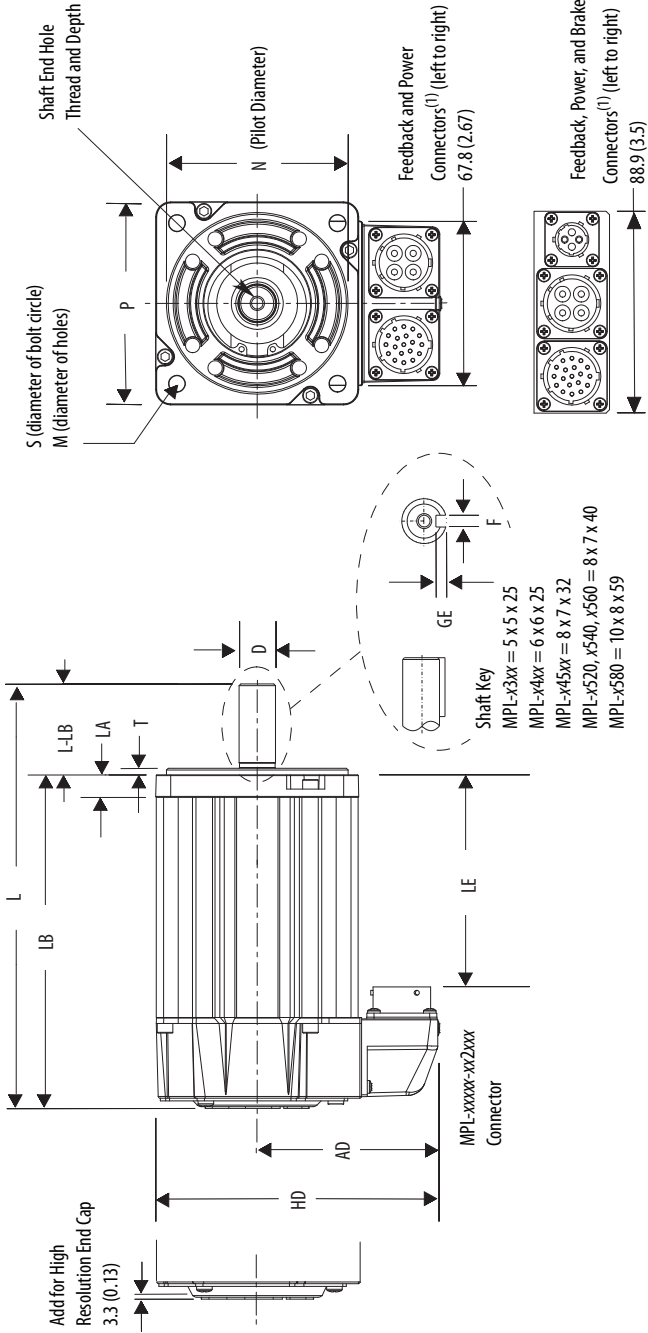

(1) Electronic zero (index pulse or Stegmann ABS = 0) occurs when the shaft key or dimple (not shown) is aligned with the connectors (as shown).

Dimensions for Bayonet Connectors (catalog number MPL-xxxx-xx2xxx)

Motor Cat. No.	AD mm (in.)	D* mm (in.)	HD mm (in.)	L (1), (2) mm (in.)	L-LB (3) mm (in.)	LA mm (in.)	LB (1), (2) mm (in.)	LD (1) mm (in.)	M mm (in.)	N* mm (in.)	P mm (in.)	S (4) mm (in.)	T mm (in.)	F (5) mm (in.)	GE (6) mm (in.)	End of Shaft Thread and Depth of Hole
MPL-A/B310				164.7 (6.49)			124.7 (4.91)	70.7 (2.78)								
MPL-A/B320	80.9 (3.19)	16.0 (0.629)	125.7 (4.95)	190.1 (7.49)	40.0 (1.58)	9.9 (0.39)	150.1 (5.91)	96.1 (3.78)	100.0 (3.937)	80.0 (3.15)	89.4 (3.52)	7.0 (0.283)	2.87 (0.113)	5.0 (0.20)	3.0 (0.12)	M5 x 0.8-6H x 12.5 (0.49)
MPL-A/B330				215.5 (8.49)			175.5 (6.91)	121.5 (4.78)								
MPL-A/B420	83.9 (3.3)	19.0 (0.748)	132.8 (5.23)	186.5 (7.35)	40.0 (1.575)	10.2 (0.40)	146.5 (5.77)	92.5 (3.64)	115.0 (4.528)	95.0 (3.74)	98.3 (3.87)	10.0 (0.401)	2.87 (0.113)	6.0 (0.24)	3.5 (0.138)	M6 x 1.0-6H x 16 (0.63)
MPL-A/B430				211.9 (8.345)			171.9 (6.77)	117.9 (4.64)								
MPL-A/B4530				225.2 (8.87)			175.2 (6.90)	121.2 (4.77)								
MPL-A/B4540	91.5 (3.6)	24.0 (0.945)	148.3 (5.84)	250.6 (9.87)	50.0 (1.97)	12.2 (0.48)	200.6 (7.90)	146.6 (5.77)	130.0 (5.118)	110.0 (4.331)	113.7 (4.48)	10.0 (0.401)	3.38 (0.133)	8.0 (0.31)	4.0 (0.158)	M8 x 1.25-6H x 19 (0.75)
MPL-A/B4560				304.7 (11.99)			254.7 (10.03)	197.4 (7.77)								
MPL-A/B520				233.7 (9.20)			173.7 (6.84)	115.8 (4.56)								
MPL-A/B540	106.2 (4.18)	28.0 (1.1)	178.1 (7.01)	284.5 (11.20)	60.0 (2.38)	13.97 (0.55)	224.5 (8.84)	166.9 (6.57)	165.0 (6.496)	130.0 (5.118)	143.5 (5.65)	12.0 (0.481)	3.38 (0.133)	8.0 (0.31)	4.0 (0.158)	M10 x 1.5-6H x 22 (0.87)
MPL-A/B560				335.3 (13.20)			275.3 (10.84)	217.7 (8.56)								
MPL-B580 7		32.0 (1.26)		406.1 (15.99)	80.0 (3.15)		326.1 (12.84)	268.5 (10.57)						10.0 (0.39)	5.0 (0.197)	M12 x 1.75-6H x 28 (1.10)

(3) Tolerance is ±0.7 (±0.028).

 (1) Motors with brake, add this value to the dimension:
 MPL-A310 through -4330: add 34.5 mm (1.36 in.) to L, LB, and LD.
 MPL-A420 through -4560: add 48.5 mm (1.91 in.) to L, LB, and LD.

MPL-A520 through -580: add 51.6 mm (2.03 in.) to L and LB, and 45.6 mm (1.79 in.) to LD.

(2) Motors with high-resolution feedback, add 3.3 mm (0.13 in.) to L and LB.

 * Refer to Kinetix Rotary Motion Specifications Technical Data, publication [GM-C1D001](#), for tolerances on these measurements.

(7) This motor is available only with 460V windings (catalog number MPL-B580).

Dimensions for Rotatable Circular DIN Connectors (catalog number MPL-xxxxx-xx7xxx)

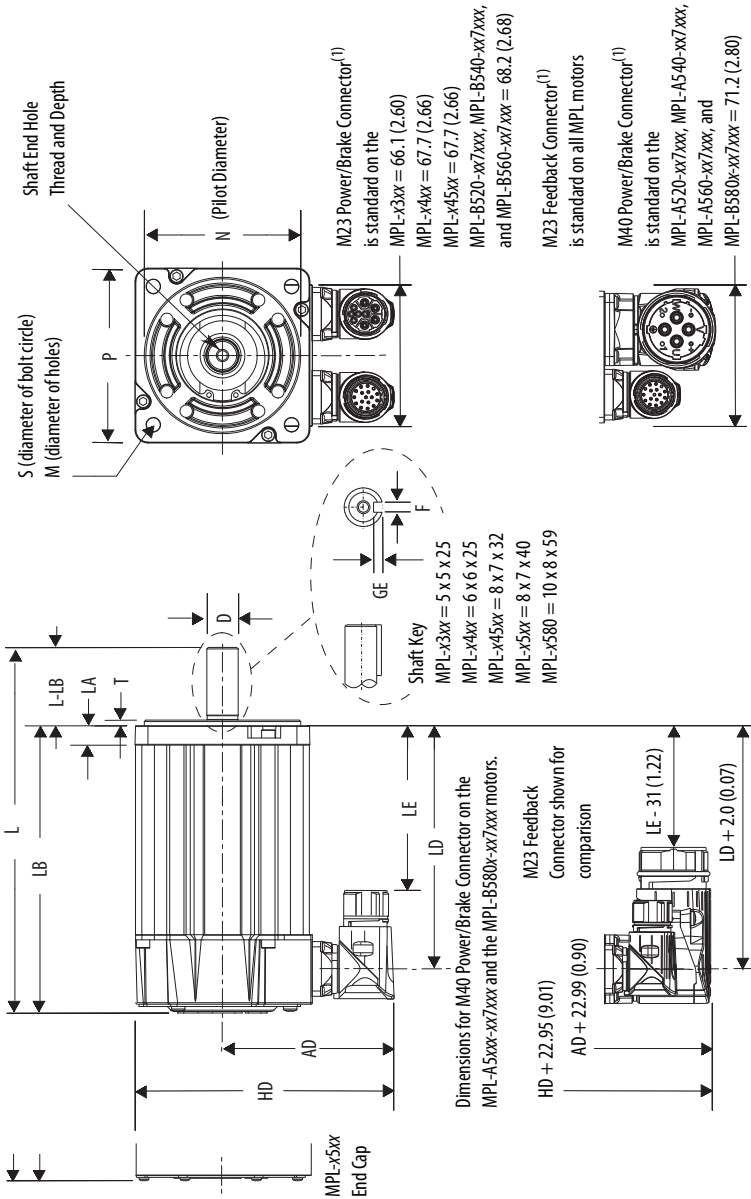

(1) Electronic zero (index pulse or Stegmann ABS = 0) occurs when the shaft key or dimple (not shown) is aligned with the connectors (as shown).

Dimensions for Rotatable Circular DIN Connectors (catalog number MPL-xxxxx-xx7xxx)

Motor Cat. No.	AD mm (in.)	D* mm (in.)	HD mm (in.)	L (1) mm (in.)	L-LB (2) mm (in.)	LA mm (in.)	LB (1) mm (in.)	LD (1) mm (in.)	LE (1) mm (in.)	M mm (in.)	N* mm (in.)	P mm (in.)	S (3) mm (in.)	T mm (in.)	F (4) mm (in.)	GE (5) mm (in.)	End of Shaft Thread and Depth of Hole
MPL-A/B310				168.0 (6.62)			128.0 (5.04)	62.0 (2.45)	102.0 (4.03)								
MPL-A/B320	87.2 (3.44)	16.0 (0.629)	132.0 (5.20)	193.0 (7.62)	40.0 (1.575)	9.90 (0.39)	153.0 (6.04)	88.0 (3.45)	128.0 (5.03)	100.0 (3.937)	80.0 (3.15)	89.4 (3.52)	7.0 (0.283)		5.0 (0.20)	3.0 (0.12)	M5 x 0.8-6H x 12.5 (0.49)
MPL-A/B330				219.0 (8.62)			179.0 (7.04)	113.0 (4.45)	153.0 (6.03)					2.74 (0.108)			
MPL-A/B420	90.9 (3.58)	19.0 (0.749)	140.1 (5.52)	190.0 (7.48)	40.0 (1.575)	10.16 (0.40)	150.0 (5.90)	84.0 (3.31)	124.0 (4.89)	115.0 (4.528)	95.0 (3.74)	98.3 (3.87)	10.0 (0.401)		6.0 (0.234)	3.5 (0.138)	M6 x 1.0-6H x 16 (0.63)
MPL-A/B430				215.0 (8.48)			175.0 (6.90)	110.0 (4.31)	150.0 (5.89)								
MPL-A/B4530				229.0 (9.0)			179.0 (7.03)	113.0 (4.44)	153.0 (6.02)								
MPL-A/B4540	98.6 (3.88)	24.0 (0.945)	155.4 (6.12)	234.0 (10.0)	50.0 (1.97)	12.19 (0.48)	204.0 (8.03)	138.0 (5.44)	178.0 (7.02)	130.0 (5.118)	110.0 (4.331)	113.7 (4.48)	10.0 (0.401)	2.74 (0.108)	8.0 (0.31)	4.0 (0.158)	M8 x 1.25-6H x 19 (0.75)
MPL-A/B4560				305 (12.0)			255.0 (10.03)	189.0 (7.44)	229.0 (9.02)								
MPL-A/B520				237.0 (9.33)			176.0 (6.92)	109.0 (4.30)	149.0 (5.88)								
MPL-A/B540	113.4 (4.47)	28.0 (1.102)	185.2 (7.29)	287.0 (11.30)	60.0 (2.38)	14.0 (0.55)	227.0 (8.92)	162.0 (6.30)	200.0 (7.88)	165.0 (6.496)	130.0 (5.118)	143.5 (5.65)	12.0 (0.481)	3.12 (0.123)	8.0 (0.31)	4.0 (0.158)	M10 x 1.5-6H x 22 (0.87)
MPL-A/B560				337.0 (13.27)			277.0 (10.90)	211.0 (8.30)	251.0 (9.88)								
MPL-B580 ⁶	136.4 (5.37)	32.0 (1.259)	208.1 (8.19)	408.0 (16.06)	80.0 (3.15)		328.0 (12.91)	232.0 (9.13)	304.0 (11.95)						10.0 (0.39)	5.0 (0.197)	M12 x 1.75-6H x 28 (1.10)

(1) Motors with brake, add this value to the dimension:
 MPL-x310 through -x330: add 35.0 mm (1.37 in.) to L, LB, and LD.
 MPL-x420 through -x4560: add 48.0 mm (1.89 in.) to L, LB, and LD.
 MPL-x520 through -x560: add 51.0 mm (2.03 in.) to L and LB, and LD.
 MPL-B580: add 45.6 mm (1.79 in.) to L and LB, and 52.0 mm (2.05 in.) to LD and LE.

(2) Tolerance for this dimension is ±0.7 (±0.028).

(3) x3xx and x4xx tolerance is +0.36 (±0.0007), x5xx is +0.43 (±0.008).

(4) Tolerance for this dimension is -0.03 (-0.001).

(5) Tolerance for this dimension is +0.1 (+0.004).

(6) MPL-B580x is available only with 460V windings.

* Refer to Kinetix Rotary Motion Specifications Technical Data, publication [GMC-D001](#), for tolerances on these measurements.

Motor Load Force Ratings

Motors are capable of operating with a sustained shaft load. The radial and axial load force location is shown in the figure, and maximum values are in the tables.

Load Forces on Shaft

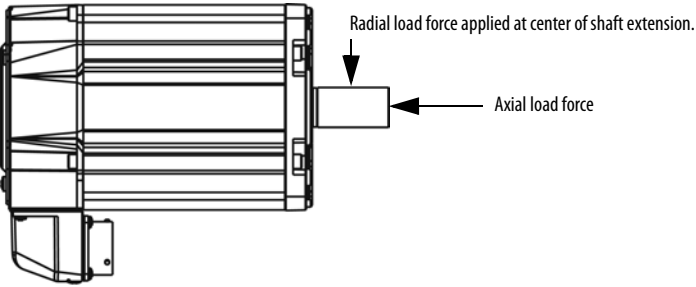

The following tables represent 20,000 hour L_{10} bearing fatigue life at various loads and speeds. This 20,000 hour life does not account for possible application-specific life reduction that can occur due to bearing grease contamination from external sources.

Radial Load Force Ratings

Motor Cat. No.	500 rpm		1000 rpm		2000 rpm		3000 rpm		3500 rpm		4000 rpm		5000 rpm	
	kg	(lb)	kg	(lb)	kg	(lb)	kg	(lb)	kg	(lb)	kg	(lb)	kg	(lb)
MPL-A/B4560	151	(332)	119	(263)	95	(209)	83	(183)	—	—	—	—	—	—
MPL-A/B520	—	—	127	(280)	100	(222)	88	(194)	—	—	80	(176)	—	—
MPL-A/B540	—	—	143	(316)	114	(251)	99	(219)	—	—	90	(199)	—	—
MPL-A/B560	—	—	153	(338)	121	(268)	106	(234)	—	—	—	—	—	—
MPL-B580	—	—	153	(338)	121	(268)	106	(234)	—	—	—	—	—	—

Axial Load Force Ratings (maximum radial load)

Motor Cat. No.	500 rpm		1000 rpm		2000 rpm		3000 rpm		3500 rpm		4000 rpm		5000 rpm	
	kg	(lb)	kg	(lb)	kg	(lb)	kg	(lb)	kg	(lb)	kg	(lb)	kg	(lb)
MPL-A/B4560	53	(117)	40	(88)	30	(65)	24	(53)	—	—	—	—	—	—
MPL-A/B520	—	—	42	(94)	30	(68)	26	(58)	—	—	22	(50)	—	—
MPL-A/B540	—	—	48	(107)	35	(79)	30	(66)	—	—	26	(58)	—	—
MPL-A/B560	—	—	52	(115)	43	(95)	32	(71)	—	—	—	—	—	—
MPL-B580	—	—	52	(115)	43	(95)	32	(71)	—	—	—	—	—	—

Axial Load Force Ratings (zero radial load)

Motor Cat. No.	500 rpm		1000 rpm		2000 rpm		3000 rpm		3500 rpm		4000 rpm		5000 rpm	
	kg	(lb)	kg	(lb)	kg	(lb)	kg	(lb)	kg	(lb)	kg	(lb)	kg	(lb)
MPL-A/B4560	69	(152)	51	(112)	38	(83)	31	(69)	—	—	—	—	—	—
MPL-A/B520	—	—	67	(149)	49	(109)	41	(92)	—	—	36	(81)	—	—
MPL-A/B540	—	—	67	(149)	49	(109)	41	(92)	—	—	36	(81)	—	—
MPL-A/B560	—	—	67	(149)	49	(109)	41	(92)	—	—	—	—	—	—
MPL-B580	—	—	67	(149)	49	(109)	41	(92)	—	—	—	—	—	—

Connector Data

These tables provide the signal descriptions for the feedback, power, and brake pinouts on the connectors.

MPL-xxxxx-xx2xxx Connector Pin Descriptions

Feedback Connector				
Pin	2000-line Encoder	2-pole Resolver	High Resolution Encoder for:	
			MPL-A3xx through MPL-A45xx	MPL-A5xx, and all MPL-B (460V)
A	AM+	S2	SIN+	SIN+
B	AM-	S4	SIN-	SIN-
C	BM+	S1	COS+	COS+
D	BM-	S3	COS-	COS-
E	IM+	Reserved	DATA+	DATA+
F	I-M		DATA-	DATA-
G	Ground	R1	Reserved	Reserved
H	ABS	R2		
J	Reserved	Reserved	+5 VDC	Reserved
K	EPWR_5 V			
L	ECOM		Common	
M	Reserved		Reserved	
N		Common		
P				
R	TS+	TS+	TS+	TS+
S	TS-	TS-	TS-	TS-
T	S1	Reserved	Reserved	Reserved
U	S2			
V	S3			

Power Connector	
Pin	Signal
A	Phase U
B	Phase V
C	Phase W
D	Ground

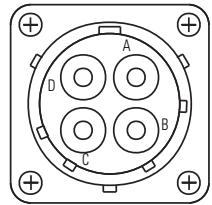

ITT Cannon
TNM 16-4 192993-0106

Brake Connector	
Pin	Signal
A	MBRK+
B	Reserved
C	MBRK-
D	Reserved

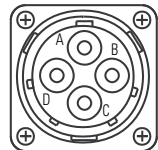

ITT Cannon
TNM 10-4 192993-0116

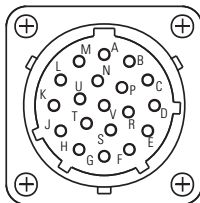

ITT Cannon
TNM 16-19 192993-0110

MPL-xxxx-xx7xxx Connector Pin Descriptions

Pin	High Resolution Encoder MPL-Axxx (230V)	High Resolution Encoder MPL-Bxxx (460V)	Incremental Encoder MPL-A/Bxxx-Hxxx
1	SIN+	SIN+	AM+
2	SIN-	SIN-	AM-
3	COS+	COS+	BM+
4	COS-	COS-	BM-
5	DATA+	DATA+	IM+
6	DATA-	DATA-	IM-
7	Reserved	Reserved	Reserved
8			Reserved
9			EPWR_5V
10			ECOM
11	Reserved	EPWR_9V	Reserved
12		ECOM	
13	TS+	TS+	TS+
14	TS-	TS-	TS-
15	Reserved	Reserved	S1
16			S2
17			S3

Pin	MPL-Axxx and MPL-Bxxx
A	Phase U ⁽²⁾
B	Phase V ⁽²⁾
C	Phase W ⁽²⁾
D	Ground ⁽²⁾
E	Reserved ⁽²⁾
F	MBRK+ ⁽²⁾
G	MBRK- ⁽²⁾
H	Reserved ⁽²⁾
L ⁽¹⁾	

M23 Power/Brake Connector

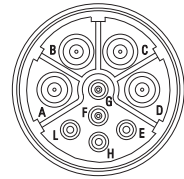

M40 Power/Brake Connector

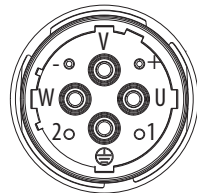

M23 Feedback Connector

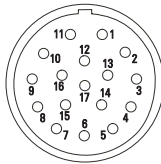

- (1) M23 (BEDC...) connector has nine pins, and the M40 (CEDE...) connector has eight pins.
- (2) Power pins A, B, C, and D can also be labeled as U, V, W, and GND respectively. Brake pins F and G brake can also be labeled as + and - respectively. Reserved pins E and H can also be numbered 1 or 2.

Remove and Install a Shaft Key

Shaft keys are constructed of steel. The specified tolerance provides an interference fit (slightly larger than the opening) for a secure and rigid connection.



ATTENTION: Do not strike the motor's shaft, couplings, or pulleys with tools during installation or removal of the shaft key.

Damage can occur to the motor bearings and the feedback device if a sharp impact is applied to the shaft during installation of couplings and pulleys, or to remove the shaft key, or if leverage is applied from the motor mounting face to remove devices mounted on the motor shaft.

Apply a constant pressure, with a wheel puller, to the user end of the shaft to remove a friction fit or stuck device.

To remove a shaft key, perform one of these actions:

- Lift the key by grasping it with a pliers or similar tool.
- Lever the key with a screwdriver inserted between the key and the slot.

To install a shaft key, follow these steps.

1. Verify the replacement key matches the keyway in the shaft and the mating mechanical connection (for example, a coupling or pulley) before proceeding.
2. Align the front of the key with the front of the motor shaft.

This prevents the radiused end-of-cut at the motor end of the keyway from interfering with correct seating of the key.

Support the underside of the shaft diameter with a fixture, and use a controlled press device to apply a constant force across the top surface to press the key into the shaft.

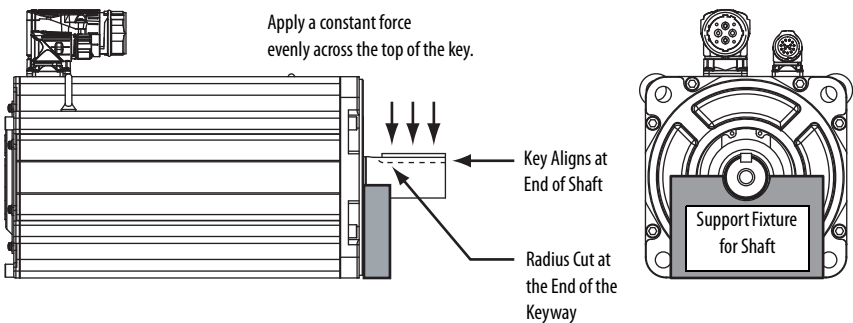

Motor Cables and Accessory Kits

This section describes accessories that are available for MP-Series low-inertia motors.

Motor Cables

Factory manufactured feedback and power cables are available in standard cable lengths. They provide the sealing needed to achieve environmental ratings and shield termination.

If you choose to build your own cables, connector kits available for MP-Series small frame motors are described in the Kinetix Motion Accessories Specifications Technical Data, publication [GMC-TD004](#).

Shaft Seal Kits

IMPORTANT Shaft seals must be lubricated. Lubricant is supplied with the shaft seal kits.

Third-party shaft seals are not approved for use with these motors. The use of third-party shaft seals voids any implied or expressed warranties.

A shaft seal is a barrier that can prevent moisture and particles from entering the motor bearings.

Shaft seals are subject to wear and require periodic inspection and replacement. Replacement is recommended every 3 months, not to exceed 12 months, depending on use.

Catalog numbers for the motors and corresponding replacement Nitrile–shaft–seal kits are listed in the table.

Motor Cat. No.	Shaft Seal Kit Cat. No.
MPL-A310, MPL-B310	MPL-SSN-A3B3
MPL-A320, MPL-B320	
MPL-A330, MPL-B330	
MPL-A420, MPL-B420	MPL-SSN-A4B4
MPL-A430, MPL-B430	
MPL-A4520, MPL-B4520	MPL-SSN-A5B5
MPL-A4530, MPL-B4530	
MPL-A4540, MPL-B4540	
MPL-A4560, MPL-B4560	MPL-SSN-F165
MPL-A520, MPL-B520, MPL-A540, MPL-B540, MPL-A560, MPL-B560	
MPL-B580	MPL-SSN-F165-32MM

For instructions on how to install a shaft seal, refer to the Shaft Seal Kit Installation Instructions, publication [2090-IN012](#).

Specifications

Attribute	Value
Temperature, operating	0...40 °C (32...104 °F) ⁽⁴⁾
Temperature, storage	-30...70 °C (-22...158 °F)
Relative humidity, storage	5...95% noncondensing
Atmosphere, storage	Noncorrosive
IP Rating ⁽¹⁾ of motor with optional shaft seal ⁽²⁾ installed	IP66 (dust tight, powerful water jets, room temperature water)
Motor without a shaft seal, and mounted in this direction:	
Shaft down	IP53
Shaft horizontal	IP51
Shaft up	IP50
Motor with ATEX rating ⁽³⁾	Group II, Zone 2 (non-mining, normal operating conditions)

(1) International protection code (IP66) is roughly equivalent to a NEMA 35 (dust tight, drip tight). IP rating descriptions are only for reference. Refer to the international standards for more complete rating descriptions.

(2) An optional shaft seal kit is required to provide the IP66 rating (excludes lower rating for cable connectors). See [Additional Resources on page 25](#) for shaft seal installation instructions.

(3) Operational environment according to ATEX directive 94/9/EC. See motor label for specific level of protection markings.

(4) To obtain the specified motor thermal rating, mount the motor on a surface with heat dissipation equivalent to a 304.8 x 304.8 x 12.7 mm (12 x 12 x 0.5 in) aluminum heatsink.

Motor feedback, auxiliary feedback, and I/O connector kits are not provided. Refer to the Kinetix Motion Accessories Specifications Technical Data, publication [GMC-TD004](#), for connector kit catalog numbers.

Additional Resources

These documents contain additional information concerning related products from Rockwell Automation.

Resource	Description
Kinetix 5500 Servo Drives User Manual, publication 2198-UM001	Provides information on installing, configuring, startup, troubleshooting, and applications for your Kinetix servo drive system.
Kinetix 6200 and Kinetix 6500 Modular Servo Drives User Manual, publication 2094-UM002	
Kinetix 6000 Multi-axis Servo Drive User Manual, publication 2094-UM001	
Kinetix 300 EtherNet/IP Indexing Servo Drives User Manual, publication 2097-UM001	
Kinetix 350 Single-axis EtherNet/IP Servo Drives User Manual, publication 2097-UM002	
Kinetix Motion Control Selection Guide, publication GMC-SG001	Specifications, motor/servo-drive system combinations, and accessories for Kinetix motion control products.
Kinetix Rotary Motion Specifications Technical Data, publication GMC-TD001	Provides product specifications for MP-Series (Bulletin MPL, MPM, MPF, MPS) rotary motors.
Kinetix Motion Accessories Specifications, publication GMC-TD004	Provides product specifications for Bulletin 2090 motor and interface cables, low-profile connector kits, drive power components, and other servo drive accessory items.
Shaft-seal Kit Installation Instructions, publication 2090-IN012	Information on the installation of a shaft seal on this and other servo motors.
Allen-Bradley Industrial Automation Glossary, publication AG-7.1	A glossary of industrial automation terms and abbreviations.
System Design for Control of Electrical Noise Reference Manual, publication GMC-RM001	How to minimize and control system-level noise.
Rockwell Automation Product Certification website http://www.rockwellautomation.com/products/certification/	Declarations of Conformity (DOC) for Rockwell Automation products.

You can view or download publications at <http://www.rockwellautomation.com/literature/>. To order paper copies of technical documentation, contact your local Allen-Bradley distributor or Rockwell Automation sales representative.

Rockwell Automation Support

Rockwell Automation provides technical information on the Web to assist you in using its products.

At <http://www.rockwellautomation.com/support> you can find technical and application notes, sample code, and links to software service packs. You can also visit our Support Center at <https://rockwellautomation.custhelp.com/> for software updates, support chats and forums, technical information, FAQs, and to sign up for product notification updates.

In addition, we offer multiple support programs for installation, configuration, and troubleshooting. For more information, contact your local distributor or Rockwell Automation representative, or visit <http://www.rockwellautomation.com/services/online-phone>.

Installation Assistance

If you experience a problem within the first 24 hours of installation, please review the information that's contained in this manual. You can also contact a special Customer Support number for initial help in getting your product up and running.

United States or Canada	1.440.646.3434
Outside United States or Canada	Use the Worldwide Locator at http://www.rockwellautomation.com/rockwellautomation/support/overview_page , or contact your local Rockwell Automation representative.

New Product Satisfaction Return

Rockwell Automation tests all of its products to help ensure that they are fully operational when shipped from the manufacturing facility. However, if your product is not functioning and needs to be returned, follow these procedures.

United States	Contact your distributor. You must provide a Customer Support case number (call the phone number above to obtain one) to your distributor to complete the return process.
Outside United States	Please contact your local Rockwell Automation representative for the return procedure.

Documentation Feedback

Your comments will help us serve your documentation needs better. If you have any suggestions on how to improve this document, complete this form, publication [RA-DU002](#), available at <http://www.rockwellautomation.com/literature/>.

Rockwell Automation maintains current product environmental information on its website at

<http://www.rockwellautomation.com/rockwellautomation/about-us/sustainability-ethics/product-environmental-compliance.page>.

Allen-Bradley, Rockwell Software, MP-Series, Kinetix, and Rockwell Automation are trademarks of Rockwell Automation, Inc.

Trademarks not belonging to Rockwell Automation are property of their respective companies.

Rockwell Otomasyon Ticaret A.Ş., Kar Plaza İş Merkezi E Blok Kat:6 34752 İçerenköy, İstanbul, Tel: +90 (216) 5698400

www.rockwellautomation.com

Power, Control and Information Solutions Headquarters

Americas: Rockwell Automation, 1201 South Second Street, Milwaukee, WI 53204-2496 USA, Tel: (1) 414.382.2000, Fax: (1) 414.382.4444

Europe/Middle East/Africa: Rockwell Automation NV, Pegasus Park, De Kleetlaan 12a, 1831 Diegem, Belgium, Tel: (32) 2 663 0600, Fax: (32) 2 663 0640

Asia Pacific: Rockwell Automation, Level 14, Core F, Cyberport 3, 100 Cyberport Road, Hong Kong, Tel: (852) 2887 4788, Fax: (852) 2508 1846

Publication MP-IN0011-EN-P - January 2015

Supersedes Publication MP-IN0011-EN-P - January 2014

Copyright © 2015 Rockwell Automation, Inc. All rights reserved. Printed in the U.S.A.